

Tarifa 2010



Encimeras, Mostradores y Molduras

FABRICA Y EXPOSICION

MUECOB MAROC S.a.r.l
Lot Tarik, N° 12, Ain Hayani 90000
Tanger (Maroc)
Tel/Fax: +212 (0) 539 93 65 76
www.muecob.com
I.F. N° 40149934 / R.C. N° 44851 /
PATENTE N° 50249145

MOBILIER DE CUISINE



www.muecob.com

CONDICIONES GENERALES DE VENTA



CONDICIONES GENERALES

- La presente tarifa anula y sustituye a las anteriores, reservándose Muecob el derecho a modificarla, si las condiciones del mercado lo requieren.
- Los precios están expresados en dirhams e incluyen el correspondiente IVA.
- Las características indicadas en la descripción de los diferentes artículos, son orientativas, reservándose Muecob el derecho a modificarlas.
- Los pedidos de material deben ser enviados a Muecob por escrito indicando de forma clara la descripción del artículo y en el caso de las puertas, las medidas de las mismas en el formato alto x ancho en milímetros, a poder ser por ordenador. Deben enviarse por fax, por correo electrónico o entregarse en mano en la oficina.
- El material que precise fabricación, o sea contra pedido, una vez fabricado no se admite modificación alguna (puertas, cristales, herrajes... etc.).
- Las pedidos de POLILAMINADO (PVC) y las puertas de CUATRO CANTOS ALUMINIO MACIZO no se pueden modificar pasadas 24 horas.
- No se admitirá ninguna reclamación transcurridos 10 días de la entrega del pedido.
- La retirada de cualquier material en el domicilio del cliente o devolución en nuestro almacén estará condicionada a la aceptación del material por Muecob, y conllevará unos gastos equivalentes al 15% del importe de dicho material.
- No se admitirá ninguna reclamación por diferencias en cantidad, defectos en el material entregado, salvo indicación expresa en el albarán del transportista.
- Los gastos correspondientes a envíos de material por agencia de transporte serán siempre por cuenta del cliente.
- La forma de pago para primeras operaciones con clientes nuevos será al contado.
- En caso de existir facturas con fecha de pago vencida, pendientes de liquidación, se suspenderá el suministro de material hasta que la deuda sea satisfecha incluidos los gastos financieros, si los hubiera.
- Los precios no incluyen el transporte. Por cada entrega con nuestros camiones o furgonetas, se cobrará la cantidad establecida en concepto de portes.
- La descarga de nuestros camiones, corre siempre por cuenta del cliente. Nuestro compromiso a este respecto, se limita al transporte hasta la zona habilitada para la descarga en sus instalaciones. No obstante nuestros transportistas tienen instrucciones para colaborar en la descarga, pero en ningún caso es su obligación. No se realizan entregas en domicilios particulares.

DESCUENTOS

- Para obtener sus descuentos sobre tarifa (solo profesionales), contacte con el departamento comercial de Muecob.
- Para cualquier solicitud de información referente a producto, plazos etc.... le rogamos contacte con el departamento comercial de Muecob.

ÍNDICE

Página

ENCIMERAS Y MOSTRADORES

- ESPECIFICACIONES TECNICAS 4
- DISEÑOS 6
- PRECIOS 9

MOLDURAS

- ESPECIFICACIONES TECNICAS 13
- PRECIOS 14



Muecob
maroc
MOBILIER DE CUISINE

-ENCIMERAS Y MOSTRADORES-

ESPECIFICACIONES TECNICAS

PERFILES-

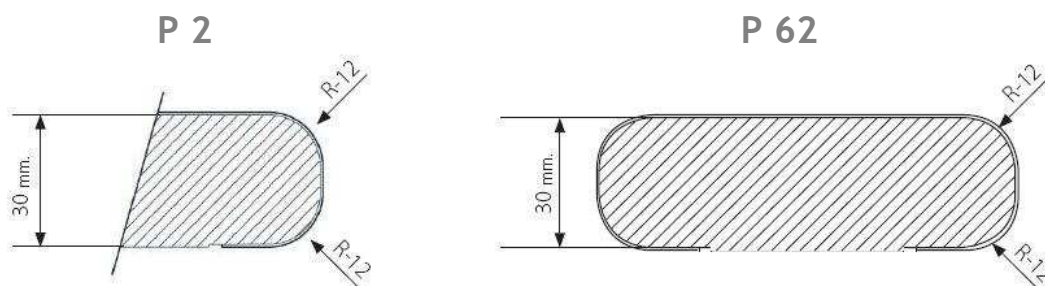

DATOS TECNICOS	
TERMINACIÓN	Postformado con radio 12.
SOPORTE	Aglomerado de 30 mm. de espesor.
RECUBRIMIENTO	Laminado decorativo HPL de 0,8 / 0,6 mm. espesor y film protector.
ADHESIVO	Cola PVA - Acetato de Polivinilo.

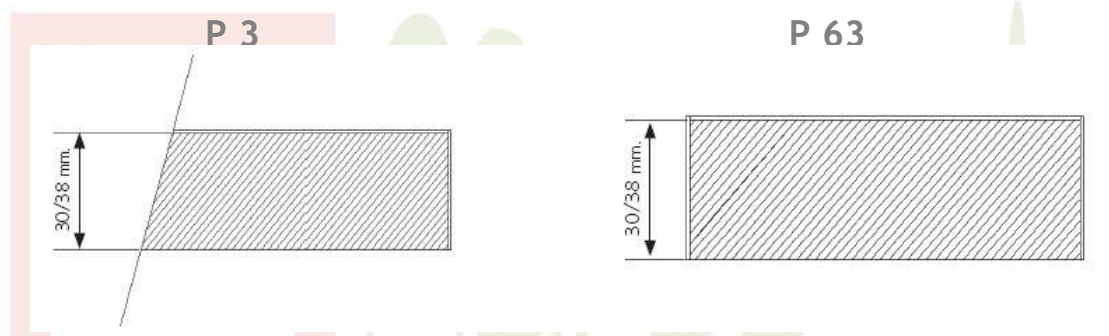

DATOS TECNICOS	
TERMINACIÓN	Recto , canteado en Acrílico.
SOPORTE	Aglomerado de 30 / 38 mm. de espesor
RECUBRIMIENTO	Laminado decorativo HPL de 0,8 / 0,6 mm. de espesor y film protector.
ADHESIVO	Cola PVA - Acetato de Polivinilo.

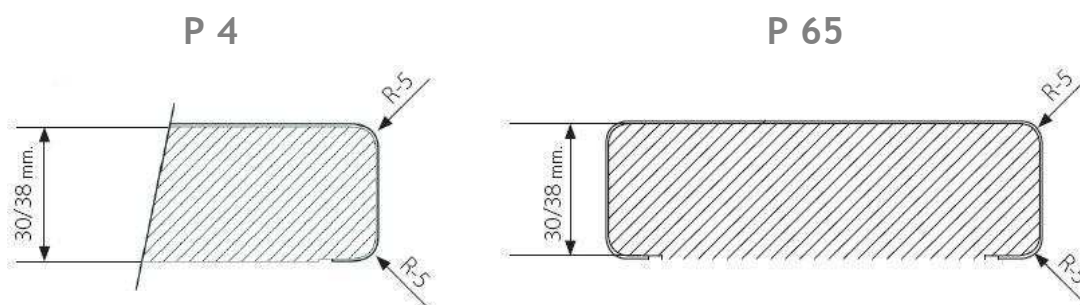

DATOS TECNICOS	
TERMINACIÓN	Postformado con radio 5.
SOPORTE	Aglomerado de 30 / 80 mm. de espesor
RECUBRIMIENTO	Laminado decorativo HPL de 0,6 mm. de espesor y film protector.
ADHESIVO	Cola PVA - Acetato de Polivinilo.

-ENCIMERAS Y MOSTRADORES-

ESPECIFICACIONES TECNICAS

-PERFILES-

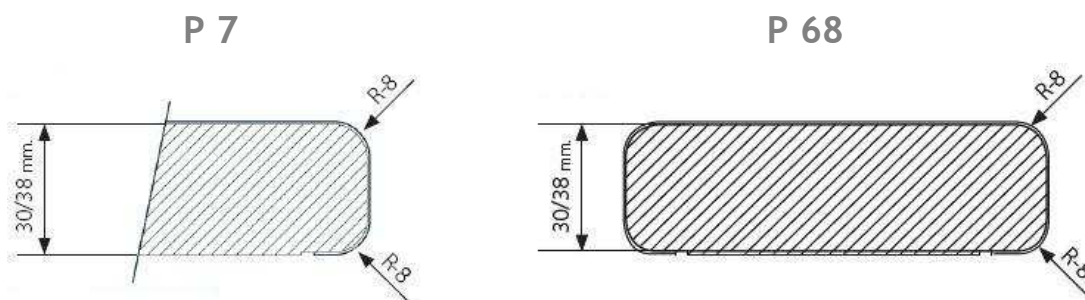

DATOS TECNICOS	
TERMINACIÓN	Postformado con radio 8..
SOPORTE	Aglomerado de 30 / 80 mm. de espesor.
RECUBRIMIENTO	Laminado decorativo HPL de 0,8 / 0,6 mm. de espesor y film protector.
ADHESIVO	Cola PVA - Acetato de Polivinilo.

DISPONIBILIDAD

LA GAMA DE ENCIMERAS DISPONE DE DOS NIVELES DECALIDAD:

BASE: Tablero aglomerado standard de 30 mm. de espesor recubierto de laminado.

SUPRA: Tablero aglomerado standard o hidrófugo de 30 / 38 mm de espesor recubierto de laminado con contracara, junta de estanqueidad y canto posterior.

LA GAMA DE MOSTRADORES DISPONE DE UN NIVEL DE CALIDAD:

SUPRA: Tablero aglomerado standard de 30 / 38 mm. de espesor recubierto de laminado y con contracara blanca.

-ENCIMERAS-

TABLERO	30 mm.			38 mm.	
	STANDARD	HIDROFUGO	HIDROFUGO	STANDARD	HIDROFUGO
CALIDAD	BASE	SUPRA	SUPRA	SUPRA	SUPRA
PERFIL 2	●	⊘	⊘	⊘	⊘
PERFIL 3	⊘	●	●	● (1)	● (1)
PERFIL 4	⊘	●	●	●	●
PERFIL 7	●	●	●	●	●
ANCHO	630	630	630	620	620

(1) Ancho 630

-MOSTRADORES-

TABLERO	30 mm	38 mm.
	STANDARD	STANDARD
CALIDAD	SUPRA	SUPRA
PERFIL 62	●	⊘
PERFIL 63	●	●
PERFIL 65	●	●
PERFIL 68	●	●

Ancho Mínimo: 400 mm.
Ancho Máximo 1240 mm.
Anchos Standard: 650, 670, 700,
800, 900, 1000, 1200 y 1240

● Disponible ⊘ No Disponible

-ENCIMERAS Y MOSTRADORES-

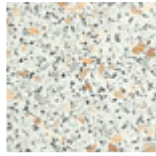

1900



1906



1907

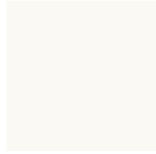

3091



8001



AB-926

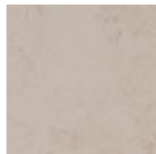

ANT-446



ARA-243



ARE-261



B-727

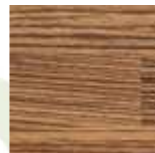

BEN-279



BLK-262



CAT-178



CEN-137



COV-222



DAV-442



F-246



F-249

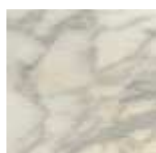

F-271



F-281



GLC-158



GLG-400



GLO-122



GLP-283

-ENCIMERAS Y MOSTRADORES-



GLR-244



GRB-240



GRM-9371



GRP-239



GRR-9364



GRT-241



GTS-9641



GTV-9622



H-203



ICO-120



IHC-119



IHO-118



L-190



MAR-230



MIR-190



NAA-146



NAB-145

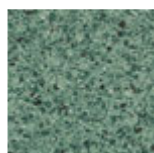

NAV-147



OAS-278



OXA-445



OXM-444

-ENCIMERAS Y MOSTRADORES-



PIZ-224



PP-5564



PP-5568



PP-7581



PSF-143



RAA-139



RAM-138

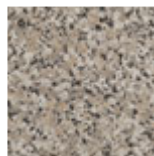

RG-102



RGA-9620



RGR-9640



SLN-440



SLR-441



SMA-807



TOR-264



TRA-260



TRC-443



UBT-263



VAC-237



W-22



WOO-242

-ENCIMERAS NEW CONCEPT-

ESPESOR TABLERO		30 mm. EURO m/l.			38 mm. EURO m/l.		LAMINADO EURO m2.
		STANDARD		HIDROFUGO	STANDARD	HIDROFUGO	
REFERENCIA	ACABADO	BASE	SUPRA	SUPRA	SUPRA	SUPRA	
1900	TF	322,55	349,21	433,54	382,25	466,58	255,60
1907	MATE	330,66	357,32	441,66	390,94	474,69	255,60
3091	G-96	413,83	440,50	524,54	473,53	557,87	255,60
3305	BRILLO	555,84	555,84	635,24	587,13	666,54	499,91
3306	BRILLO	555,84	555,84	635,24	587,13	666,54	499,91
3307	BRILLO	555,84	555,84	635,24	587,13	666,54	499,91
3308	BRILLO	555,84	555,84	635,24	587,13	666,54	499,91
3309	BRILLO	555,84	555,84	635,24	587,13	666,54	499,91
3310	BRILLO	555,84	555,84	635,24	587,13	666,54	499,91
3311	BRILLO	555,84	555,84	635,24	587,13	666,54	499,91
3313	BRILLO	555,84	555,84	635,24	587,13	666,54	499,91
3314	BRILLO	555,84	555,84	635,24	587,13	666,54	499,91
3315	BRILLO	555,84	555,84	635,24	587,13	666,54	499,91
3316	BRILLO	555,84	555,84	635,24	587,13	666,54	499,91
3317	BRILLO	555,84	555,84	635,24	587,13	666,54	499,91
6510	BRILLO	441,66	468,32	552,65	501,35	585,69	295,60
8001	TF	330,66	357,32	441,66	390,94	474,69	255,60
AB-926	BRILLO	456,72	483,39	567,72	516,42	600,76	290,38
ANT-446	STONE	368,63	395,29	479,62	428,32	512,66	304,29
ARA-243	BRILLO	344,86	371,52	456,15	403,98	490,63	255,60
ARE-261	STONE	344,86	371,52	456,15	403,98	490,63	290,38
BLK-262	STONE	344,86	371,52	456,15	403,98	490,63	290,38
CAT-178	SOFT	330,66	357,32	441,66	390,94	474,69	339,65
CEN-137	SOFT	330,66	357,32	441,66	390,94	474,69	255,60
COV-222	TF	368,63	395,29	479,62	428,32	512,66	255,60
D-93	QUARZ	423,11	449,77	533,81	483,10	567,14	288,35
DAV-442	SOFT	368,63	395,29	479,62	428,32	512,66	263,72
F-249	BRILLO	344,86	371,52	456,15	403,98	490,63	255,60
F-271	BRILLO	344,86	371,52	456,15	403,98	490,63	255,60
F-281	BRILLO	344,86	371,52	456,15	403,98	490,63	255,60
F-281	TF	344,86	371,52	456,15	403,98	490,63	255,60
GIB-9126	G-96	456,72	483,39	567,72	516,42	600,76	290,38
GLC-158	TF	368,63	395,29	479,62	428,32	512,66	255,60
GLG-400	TF	368,63	395,29	479,62	428,32	512,66	255,60
GLO-122	TF	368,63	395,29	479,62	428,32	512,66	255,60
GLP-283	SLATE	368,63	395,29	479,62	428,32	512,66	255,60
GLR-244	TF	368,63	395,29	479,62	428,32	512,66	255,60
GRM-9371	BRILLO	456,72	483,39	567,72	516,42	600,76	309,22
GRR-9364	BRILLO	456,72	483,39	567,72	516,42	600,76	309,22
H-203	SOFT	322,55	349,21	433,54	382,25	466,58	255,60
ICO-120	SOFT	322,55	349,21	433,54	382,25	466,58	255,60
IHC-119	SOFT	322,55	349,21	433,54	382,25	466,58	255,60
IHO-118	SOFT	322,55	349,21	433,54	382,25	466,58	255,60

-ENCIMERAS NEW CONCEPT-

ESPESOR		30 mm. EURO m/l.			38 mm. EURO m/l.		LAMINADO EURO m2.
TABLERO		STANDARD		HIDROFUGO	STANDARD	HIDROGUGO	
REFERENCIA	ACABADO	BASE	SUPRA	SUPRA	SUPRA	SUPRA	
KMM-740	WAX	368,63	395,29	479,62	428,32	512,66	304,29
L-190	SOFT	322,55	349,21	433,54	382,25	466,58	239,66
L-706	BRILLO	423,11	449,77	533,81	483,10	567,14	247,49
MAR-230	BRILLO	368,63	395,29	479,62	428,32	512,66	255,60
MIR-190	SOFTMAT	344,86	371,52	456,15	403,98	490,63	255,60
MTA-768	AS EXT	555,84	555,84	635,24	587,13	666,54	360,80
MTC-769	AS EXT	555,84	555,84	635,24	587,13	666,54	360,80
NAA-146	TF	330,66	357,32	441,66	390,94	474,69	255,60
NAB-145	TF	330,66	357,32	441,66	390,94	474,69	255,60
NMN-744	BRILLO	368,63	395,29	479,62	428,32	512,66	304,29
OAS-278	STONE	344,86	371,52	456,15	403,98	490,63	290,38
OLT-183	SOFT	423,11	449,77	533,81	483,10	567,14	290,38
OP-632	BRILLO	413,83	440,50	524,54	473,53	557,87	255,60
OXA-445	WAX	368,63	395,29	479,62	428,32	512,66	263,72
OXM-444	WAX	368,63	395,29	479,62	428,32	512,66	263,72
PIZ-224	SOFT	330,66	357,32	441,66	390,94	474,69	255,60
PP-5564	BRILLO	423,11	449,77	533,81	483,10	567,14	290,38
PP-5568	BRILLO	441,66	468,32	552,65	501,35	585,69	290,38
PP-653	G-96	423,11	449,77	533,81	483,10	567,14	309,22
PP-654	G-96	423,11	449,77	533,81	483,10	567,14	309,22
PP-7581	SOFT	330,66	357,32	441,66	390,94	474,69	290,38
PP-7581	BRILLO	330,66	357,32	441,66	390,94	474,69	290,38
PPC-741	BRILLO	368,63	395,29	479,62	428,32	512,66	304,29
PPC-741	WAX	368,63	395,29	479,62	428,32	512,66	304,29
PPG-742	BRILLO	368,63	395,29	479,62	428,32	512,66	304,29
PPG-742	WAX	368,63	395,29	479,62	428,32	512,66	304,29
PPN-743	BRILLO	368,63	395,29	479,62	428,32	512,66	304,29
PPN-743	WAX	368,63	395,29	479,62	428,32	512,66	304,29
PSF-143	SOFTMAT	344,86	371,52	456,15	403,98	490,63	255,60
RAA-139	SOFT	330,66	357,32	441,66	390,94	474,69	255,60
RAM-138	SOFT	330,66	357,32	441,66	390,94	474,69	255,60
RG-102	BRILLO	330,66	357,32	441,66	390,94	474,69	290,38
RG-102	TF	330,66	357,32	441,66	390,94	474,69	290,38
RGA-9620	BRILLO	330,66	357,32	441,66	390,94	474,69	290,38
RGR-9640	BRILLO	330,66	357,32	441,66	390,94	474,69	290,38
SLN-440	SLATE	368,63	395,29	479,62	428,32	512,66	304,29
SLR-441	STONE	368,63	395,29	479,62	428,32	512,66	304,29
SMA-807	CM	562,79	589,45	673,50	622,20	706,53	474,69
TOR-264	STONE	344,86	371,52	456,15	403,98	490,63	290,38
TRA-260	STONE	344,86	371,52	456,15	403,98	490,63	290,38
TRC-443	WAX	368,63	395,29	479,62	428,32	512,66	263,72
UBT-263	STONE	344,86	371,52	456,15	403,98	490,63	290,38
WOO-242	SOFT	322,55	349,21	433,54	382,25	466,58	255,60

-MOSTRADORES NEW CONCEPT-

ESPESOR		30 mm. EURO m/l.			38 mm. EURO m/l.		LAMINADO EURO m2.
TABLERO		STANDARD		HIDROFUGO	STANDARD	HIDROFUGO	
REFERENCIA	ACABADO	BASE	SUPRA	SUPRA	SUPRA	SUPRA	
1900	TF	503,96	609,74	681,90	538,16	643,94	715,52
1907	MATE	514,40	621,91	695,81	548,30	655,82	729,72
3091	G-96	649,15	768,26	861,29	683,06	802,17	895,19
3305	BRILLO	915,77	1147,32	1284,10	947,36	1178,62	1315,40
3306	BRILLO	915,77	1147,32	1284,10	947,36	1178,62	1315,40
3307	BRILLO	915,77	1147,32	1284,10	947,36	1178,62	1315,40
3308	BRILLO	915,77	1147,32	1284,10	947,36	1178,62	1315,40
3309	BRILLO	915,77	1147,32	1284,10	947,36	1178,62	1315,40
3310	BRILLO	915,77	1147,32	1284,10	947,36	1178,62	1315,40
3311	BRILLO	915,77	1147,32	1284,10	947,36	1178,62	1315,40
3313	BRILLO	915,77	1147,32	1284,10	947,36	1178,62	1315,40
3314	BRILLO	915,77	1147,32	1284,10	947,36	1178,62	1315,40
3315	BRILLO	915,77	1147,32	1284,10	947,36	1178,62	1315,40
3316	BRILLO	915,77	1147,32	1284,10	947,36	1178,62	1315,40
3317	BRILLO	915,77	1147,32	1284,10	947,36	1178,62	1315,40
6510	BRILLO	721,31	869,40	969,96	755,22	903,02	1004,16
8001	TF	514,40	621,91	695,81	548,30	655,82	729,72
AB-926	BRILLO	745,37	931,71	1045,60	779,85	965,61	1079,79
ANT-446	STONE	571,49	676,10	758,70	605,39	710,01	791,44
ARA-243	BRILLO	542,80	648,86	727,40	576,99	683,06	760,73
ARE-261	STONE	542,80	648,86	727,40	576,99	683,06	760,73
BLK-262	STONE	542,80	648,86	727,40	576,99	683,06	760,73
CAT-178	SOFT	514,40	621,91	695,81	548,30	655,82	729,72
CEN-137	SOFT	514,40	621,91	695,81	548,30	655,82	729,72
COV-222	TF	571,49	676,10	758,70	605,39	710,01	791,44
D-93	QUARZ	683,64	840,42	924,17	717,83	874,04	958,37
DAV-442	SOFT	571,49	676,10	758,70	605,39	710,01	791,44
F-249	BRILLO	542,80	648,86	727,40	576,99	683,06	760,73
F-271	BRILLO	542,80	648,86	727,40	576,99	683,06	760,73
F-281	BRILLO	542,80	648,86	727,40	576,99	683,06	760,73
F-281	TF	542,80	648,86	727,40	576,99	683,06	760,73
GIB-9126	G-96	745,37	931,71	1045,60	779,85	965,61	1079,79
GLC-158	TF	571,49	676,10	758,70	605,39	710,01	791,44
GLG-400	TF	571,49	676,10	758,70	605,39	710,01	791,44
GLO-122	TF	571,49	676,10	758,70	605,39	710,01	791,44
GLP-283	SLATE	571,49	676,10	758,70	605,39	710,01	791,44
GLR-244	TF	571,49	676,10	758,70	605,39	710,01	791,44
GRM-9371	BRILLO	745,37	931,71	1045,60	779,85	965,61	1079,79
GRR-9364	BRILLO	571,49	676,10	758,70	605,39	710,01	791,44
H-203	SOFT	503,96	609,74	681,90	538,16	643,94	715,52
ICO-120	SOFT	503,96	609,74	681,90	538,16	643,94	715,52
IHC-119	SOFT	503,96	609,74	681,90	538,16	643,94	715,52
IHO-118	SOFT	503,96	609,74	681,90	538,16	643,94	715,52

-MOSTRADORES NEW CONCEPT-

ESPESOR		30 mm. EURO m/l.			38 mm. EURO m/l.		LAMINADO EURO m2.
TABLERO		STANDARD		HIDROFUGO	STANDARD	HIDROFUGO	
REFERENCIA	ACABADO	BASE	SUPRA	SUPRA	SUPRA	SUPRA	
KMM-740	WAX	571,49	676,10	758,70	605,39	710,01	791,44
L-190	SOFT	503,96	609,74	681,90	538,16	643,94	715,52
L-706	BRILLO	683,64	840,42	924,17	717,83	874,04	958,37
MAR-230	BRILLO	571,49	676,10	758,70	605,39	710,01	791,44
MIR-190	SOFTMAT	542,80	648,86	727,40	576,99	683,06	760,73
MTA-768	AS EXT	915,77	1147,32	1284,10	947,36	1178,62	1315,40
MTC-769	AS EXT	915,77	1147,32	1284,10	947,36	1178,62	1315,40
NAA-146	TF	514,40	621,91	695,81	548,30	655,82	729,72
NAB-145	TF	514,40	621,91	695,81	548,30	655,82	729,72
NMN-744	BRILLO	571,49	676,10	758,70	605,39	710,01	791,44
OAS-278	STONE	542,80	648,86	727,40	576,99	683,06	760,73
OLT-183	SOFT	683,64	840,42	924,17	717,83	874,04	958,37
OP-632	BRILLO	649,15	768,26	861,29	683,06	802,17	895,19
OXA-445	WAX	571,49	676,10	758,70	605,39	710,01	791,44
OXM-444	WAX	571,49	676,10	758,70	605,39	710,01	791,44
PIZ-224	SOFT	514,40	621,91	695,81	548,30	655,82	729,72
PP-5564	BRILLO	683,64	840,42	924,17	717,83	874,04	958,37
PP-5568	BRILLO	721,31	869,40	969,96	755,22	903,02	1004,16
PP-653	G-96	683,64	840,42	924,17	717,83	874,04	958,37
PP-654	G-96	683,64	840,42	924,17	717,83	874,04	958,37
PP-7581	SOFT	514,40	621,91	695,81	548,30	655,82	729,72
PP-7581	BRILLO	514,40	621,91	695,81	548,30	655,82	729,72
PPC-741	BRILLO	571,49	676,10	758,70	605,39	710,01	791,44
PPC-741	WAX	571,49	676,10	758,70	605,39	710,01	791,44
PPG-742	BRILLO	571,49	676,10	758,70	605,39	710,01	791,44
PPG-742	WAX	571,49	676,10	758,70	605,39	710,01	791,44
PPN-743	BRILLO	571,49	676,10	758,70	605,39	710,01	791,44
PPN-743	WAX	571,49	676,10	758,70	605,39	710,01	791,44
PSF-143	SOFTMAT	542,80	648,86	727,40	576,99	683,06	760,73
RAA-139	SOFT	514,40	621,91	695,81	548,30	655,82	729,72
RAM-138	SOFT	514,40	621,91	695,81	548,30	655,82	729,72
RG-102	BRILLO	514,40	621,91	695,81	548,30	655,82	729,72
RG-102	TF	514,40	621,91	695,81	548,30	655,82	729,72
RGA-9620	BRILLO	514,40	621,91	695,81	548,30	655,82	729,72
RGR-9640	BRILLO	514,40	621,91	695,81	548,30	655,82	729,72
SLN-440	SLATE	571,49	676,10	758,70	605,39	710,01	791,44
SLR-441	STONE	571,49	676,10	758,70	605,39	710,01	791,44
SMA-807	CM	991,41	1242,08	1390,17	1025,89	1275,99	1424,08
TOR-264	STONE	542,80	648,86	727,40	576,99	683,06	760,73
TRA-260	STONE	542,80	648,86	727,40	576,99	683,06	760,73
TRC-443	WAX	571,49	676,10	758,70	605,39	710,01	791,44
UBT-263	STONE	542,80	648,86	727,40	576,99	683,06	760,73
WOO-242	SOFT	503,96	609,74	681,90	538,16	643,94	715,52

-MOLDURAS-

ESPECIFICACIONES TECNICAS

P 52

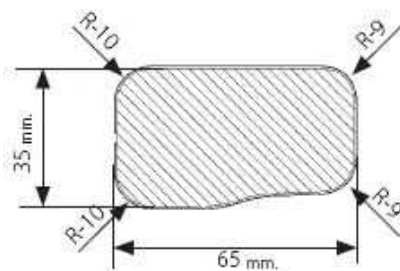

DATOS TECNICOS	
TERMINACIÓN	Postformado con Radio 9.
SOPORTE	Tablero MDF 35 mm. de espesor.
RECUBRIMIENTO	Laminado decorativo HPL de 0,7 mm. de espesor.
ADHESIVO	Cola PVA - Acetato de Polivinilo.

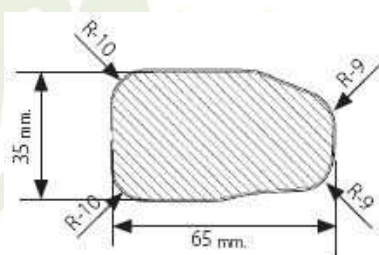
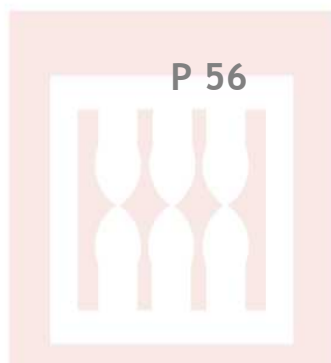

DATOS TECNICOS	
TERMINACIÓN	Postformado con Radio 9.
SOPORTE	Tablero MDF 35 mm. de espesor.
RECUBRIMIENTO	Laminado decorativo HPL de 0,7 mm. de espesor.
ADHESIVO	Cola PVA - Acetato de Polivinilo.

DISPONIBILIDAD DE MEDIDAS
Largo 3600x65x35 mm.

-MOLDURAS-

AS EXTREM		EURO m/l.
REFERENCIA	ACABADO	MOLDURA
3091	BRILLO	122,59
3273	BRILLO	133,60
COA-221	BRILLO	133,60
COV-222	BRILLO	133,60
COY-223	BRILLO	133,60
GLA-270	BRILLO	133,60
GLB-247	BRILLO	133,60
GLC-158	BRILLO	133,60
GLD-410	BRILLO	133,60
GLG-400	BRILLO	133,60
GLH-405	BRILLO	133,60
GLK-401	BRILLO	133,60
GLM-246	BRILLO	133,60
GLN-156	BRILLO	141,71
GLO-122	BRILLO	133,60
GLP-283	BRILLO	133,60
GLR-244	BRILLO	133,60
GLS-248	BRILLO	133,60
GLV-157	BRILLO	133,60
MTA-768	BRILLO	133,60
MTB-766	BRILLO	133,60
MTC-769	BRILLO	133,60
MTG-765	BRILLO	133,60
MTM-764	BRILLO	133,60
MTV-767	BRILLO	133,60

GRAFICA		EURO m/l.
REFERENCIA	ACABADO	MOLDURA
CAB-761	BRILLO	133,60
CAG-762	BRILLO	133,60
CAR-763	BRILLO	133,60
FIB-750	BRILLO	133,60
FIN-751	BRILLO	133,60
PUB-760	BRILLO	133,60
PUG-757	BRILLO	133,60
PUM-758	BRILLO	133,60
PUV-759	BRILLO	133,60
TAB-752	BRILLO	133,60
TAC-755	BRILLO	133,60
TAG-753	BRILLO	133,60
TAV-754	BRILLO	133,60

VANGUARD		EURO m/l.
REFERENCIA	ACABADO	MOLDURA
L-3091	SOFT	122,59
L-3091	BRILLO	122,59
PP-5050	P.F.	115,92
3091	SOFT	122,59
ALU-402	ALUMINIO	245,75
GRB-199	GRITT	122,59
GRC-200	GRITT	122,59
GRD-287	GRITT	122,59
GRE-285	GRITT	122,59
GRN-202	GRITT	122,59
CEN-137	BRILLO	141,71
GLI-159	BRILLO	133,60
MIR-190	BRILLO	115,92
OUB-421	BRILLO	133,60
OUG-420	BRILLO	133,60
PSF-143	BRILLO	133,60
ZEB-277	BRILLO	141,71
CAN-6590	BRILLO	133,60
CAN-6590	SOFTMAT	133,60
CDN-6595	BRILLO	133,60
CDN-6595	SOFTMAT	133,60
CMN-6588	BRILLO	133,60
CMN-6588	SOFTMAT	133,60
CNN-6589	BRILLO	133,60
CNN-6589	SOFTMAT	133,60
CVN-6592	BRILLO	133,60
CVN-6592	SOFTMAT	133,60
OLC-180	BRILLO	115,92
OLM-182	BRILLO	115,92
OLN-181	BRILLO	115,92
OLR-184	BRILLO	115,92
OLT-183	BRILLO	115,92

MOLDURAS

BASIC		EURO m/l.
REFERENCIA	ACABADO	MOLDURA
3273	SOFT	122,59
ABH-106	P.F.	109,54
ABH-106	SOFT	109,54
ABH-106	T.F.	109,54
ALU-700	SOFT	128,09
CEA-233	SOFT	115,92
CEM-234	SOFTMAT	115,92
CEN-137	SOFTMAT	122,59
CER-276	SOFTMAT	122,59
COA-221	SOFT	115,92
COC-220	SOFT	115,92
CON-288	SOFT	128,09
COV-222	SOFT	115,92
COY-223	SOFT	115,92
GLB-247	SOFT	122,59
GLP-283	SOFT	122,59
GLR-244	SOFT	133,60
H-203	SOFT	115,92
HOB-425	SOFTMAT	122,59
HOF-274	SOFTMAT	122,59
HOG-272	SOFTMAT	122,59
HOL-426	SOFTMAT	122,59
HOM-273	SOFTMAT	122,59
HON-284	SOFTMAT	122,59
HOT-275	SOFTMAT	122,59
ICO-120	SOFT	115,92
IHC-119	SOFT	115,92
IHO-118	SOFT	115,92
KNB-424	SOFTMAT	122,59
KNM-423	SOFTMAT	122,59
LYG-429	SOFTMAT	122,59
LYN-430	SOFTMAT	122,59
M-565	SOFT	128,09
MIR-190	SOFTMAT	115,92
OLC-180	SOFT	115,92
OLM-182	SOFT	115,92
OLN-181	SOFT	115,92
OLR-184	SOFT	115,92
OLT-183	SOFT	115,92
OUM-442	SOFTMAT	122,59
OUN-447	SOFTMAT	122,59
PIN-280	SOFTMAT	122,59
PSB-144	SOFTMAT	115,92
PSC-141	SOFTMAT	115,92
PSF-143	SOFTMAT	115,92
ROA-231	SOFT	115,92
WAN-428	SOFTMAT	122,59

EFECCCT		EURO m/l.
REFERENCIA	ACABADO	MOLDURA
ABH-106	TETRIX	—
ALU-700	TETRIX	—
COA-221	TETRIX	—
CON-288	TETRIX	—
COV-222	TETRIX	—
COY-223	TETRIX	—
GLB-247	TETRIX	—
GLK-401	TETRIX	—
GLP-283	TETRIX	—
GLR-244	TETRIX	—
M-565	TETRIX	—
ABH-106	V.H.	128,09
CON-288	V.H.	128,09
COV-222	V.H.	128,09
GLB-247	V.H.	128,09
GLP-283	V.H.	128,09
HOA-998	V.H.	122,59
HOG-272	V.H.	122,59
HOJ-427	V.H.	122,59
LIM-294	V.V.	128,09
M-565	V.H.	128,09
MAK-756	V.V.	128,09
OCC-293	V.V.	128,09
OCG-292	V.V.	128,09